



Range of Products

PAKARTE

*Vom Fachmann
• FROM EXPERTS • TO EXPERTS •
für den Fachmann*

DISTRIBUTOR IN BALTICS:
PAKARTE LLC
Phone+372 5656 9482
pakarte@pakarte.com
www.pakarte.com



schütze

SPRAYTECHNOLOGY

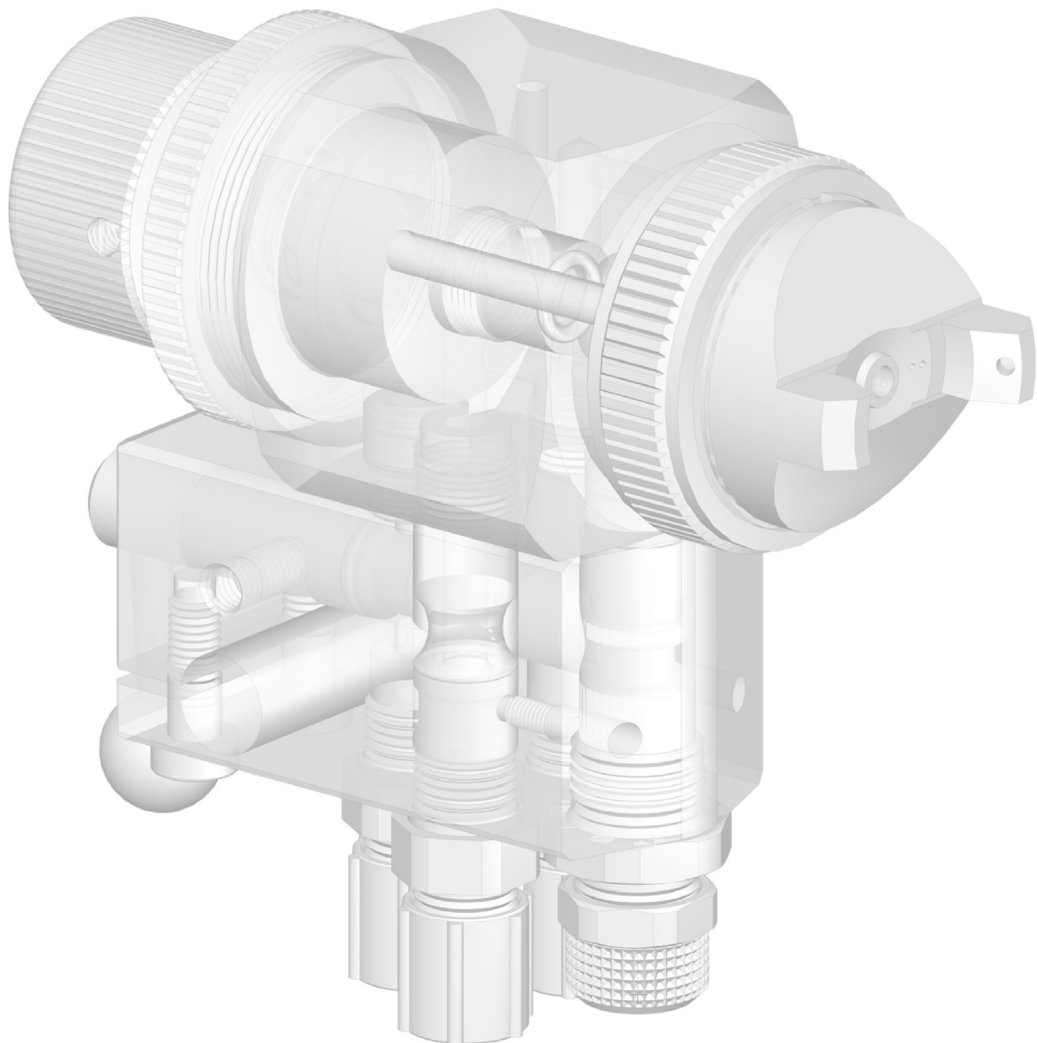

Sprayguns



SCHÜTZE S 941
Heavy duty spraygun
incl. precision air micrometer,
0.6 ltr. flowcup, plastic with
drop stop

available nozzle dimensions:
0.8, 1.0, 1.2, 1.3, 1.4, 1.5, 1.7,
2.0, 2.5, 3.0, 3.5 mm Ø

nozzle and needle:
stainless steel

gun body:
aluminium, anodized blue

weight: 720g

Also available in
HVLP-technique

Sprayguns



SCHÜTZE W 3 and W 3 F
decor and "small job"
spraygun
50 ccm flowcup, aluminium

available nozzle dimensions:
0.3, 0.5, 0.8, 1.0 mm Ø

type W 3 = roundspray
type W 3 F = flatspray

available flowcups:
50 ccm, aluminium
0.3 ltr., aluminium

nozzle and needle:
stainless steel

gun body:
aluminium, anodized blue

weight: 310g



SCHÜTZE W 1/W 1 IK
standard spraygun
0.6 ltr. flowcup, aluminium

available nozzle dimensions:
0.5, 0.8, 1.0, 1.2, 1.5, 1.8, 2.0,
2.5, 3.0, 3.5 mm Ø

nozzle and needle:
german silver,
stainless steel on request
- spiral nozzles for glues etc.
- nozzle extensions in various
versions

gun body:
aluminium, anodized blue

weight: 635g



SCHÜTZE W 3 / FZ-Duo
FINE-SPRAY gun, a special
design for spraying fluids of
low viscosity, f.i. release
agents

available nozzle dimensions:
0.2, 0.3, 0.5, 0.8, 1.0 mm Ø

nozzle and needle:
stainless steel
flatspray or roundspray
pattern depending on aircap
- spiral nozzles for glues etc.
- nozzle extensions in various
versions

gun body:
aluminium, anodized blue

weight: 245g



SCHÜTZE W 2
roundspray spraygun
0.3 ltr. flowcup, aluminium

available nozzle dimensions:
0.5, 0.8, 1.0, 1.2, 1.5, 1.8, 2.0,
2.5, 3.0 mm Ø

nozzle and needle:
german silver

gun body:
aluminium, anodized blue

weight: 530g



SCHÜTZE W 3/FZ-Duo R/F
This **FINE-SPRAY** gun is designed
especially to handle fluids of
very low viscosity f.i. release
agents. **With regulating screw**
for round-flatspray regulation.

Available nozzle sizes:
0,2; 0,3; 0,5; 0,8; 1,0 mm Ø

nozzle and needle:
stainless steel

gun body: aluminium

weight: 245g

Also available in HVLP-version
and version "KLS" for applica-
tion of adhesives.



SCHÜTZE W 4
pressure feed cup gun
0.7 ltr. pressure feedcup,
aluminium
max. material pressure = 1 bar

available nozzle dimensions:
0.5, 0.8, 1.0, 1.2, 1.5, 1.8, 2.0,
2.5, 3.0, 3.5 mm Ø

nozzle and needle:
german silver,
stainless steel on request
- spiral nozzles for glues etc.
- nozzle extensions in various
versions

gun body:
aluminium, anodized blue

weight: 950g



SCHÜTZE 2-K-spraygun
two-component-spraygun
Supply of both components
directly into each sprayhead.
Supply of atomizing air and
control air via gun body. Only
one trigger. Mixing within
spray jets. Mixing ratio can be
regulated individually.

available nozzle dimensions:
0.2, 0.3, 0.5, 0.8, 1.0, 1.2 and
1.5 mm Ø

Flat- or roundspray pattern
depending on aircap, all
material leading parts made
from stainless steel. For glues
special nozzle sets (KLS-version)
available.

weight: only 490g

Sprayguns



SCHÜTZE W 7 A-N
convertible spraygun
with feed pipe for pressure tank or pump supply

available nozzle dimensions:
0.5, 0.8, 1.0, 1.2, 1.5, 1.8, 2.0, 2.5, 3.0 mm Ø

nozzle and needle:
german silver,
stainless steel on request
- spiral nozzles for glues etc.
- nozzle extensions in various versions

gun body:
aluminium, anodized blue

weight: 650g

Sprayguns



SCHÜTZE S 947 B
heavy duty convertible spraygun
incl. precision air micrometer, 0,6 ltr. flowcup, plastic with dropstop.

available nozzle dimensions:
0.8, 1.0, 1.2, 1.3, 1.4, 1.5, 1.7, 2.0, 2.5, 3.0, 3.5 mm Ø

nozzle and needle:
stainless steel

gun body:
aluminium, anodized blue

weight: 760g

Also available in HVLP-technique



SCHÜTZE W 7 K-N
convertible spraygun
with 1 ltr. syphoncup, aluminium quick clamping lid

available nozzle dimensions:
0.5, 0.8, 1.0, 1.2, 1.5, 1.8, 2.0, 2.5, 3.0 mm Ø

nozzle and needle:
german silver,
stainless steel on request
- spiral nozzles for glues etc.
- nozzle extensions in various versions

gun body:
aluminium, anodized blue

weight: 1100g



SCHÜTZE S 947 S
heavy duty convertible spraygun
incl. precision air micrometer, with 1 ltr. syphoncup, aluminium thread lid

available nozzle dimensions:
0.8, 1.0, 1.2, 1.3, 1.4, 1.5, 1.7, 2.0, 2.5, 3.0, 3.5 mm Ø

nozzle and needle:
stainless steel

gun body:
aluminium, anodized blue

weight: 900g

Also available in HVLP-technique



SCHÜTZE S 720
Universal AIRLESS-spraygun
S 720/250 up to 250 bar
S 720/500 up to 500 bar
to be equipped with standard airless nozzles

standard supply:
- filter
- 1/4" swivel

safety devices:
trigger lock
trigger guard

weight: 700g



SCHÜTZE W 5 / P
blowgun
with 50 mm pipe (standard length), other length-available

special accessories:
rebound guard, flat nozzle, silencer nozzle, venturi nozzle...

SCHÜTZE W 5 / G
blowgun, with straight handle
with 50 mm pipe

SCHÜTZE W 5 / PB
blowgun
with silencer and increased blow power



SCHÜTZE S 720 / LV
extrusion AIRLESS gun
especially designed for glues, no atomizing of fluid.

available nozzle dimensions:
0.3, 0.4, 0.5, 0.6, 0.8, 1.0, 1.2, 1.5, 2.0 mm Ø

standard supply:
- filter
- 1/4" swivel

safety devices:
trigger lock
trigger guard

weight: 700g



SCHÜTZE WS 5/1
fluid sprayer
spraying liquids under pressure in a hollow cone jet without atomizing air.

drill-hole in nozzle plate:
1.5 mm (other drill-holes depend on liquid)

Simple design. Also to be connected to any water supply line.

weight: 300g

Automatic spray valves



SCHÜTZE spray valve MFS

pneumatically controlled spray valve. Suitable for spraying release agents, oils, colours, etc... Also in version MFS/KLS available.

nozzle and needle: stainless steel

available nozzle dimensions:

0.2, 0.3, 0.5, 0.8, 1.0, 1.2, 1.5, 2.0, 2.5 mm Ø

flatspray or roundspray pattern depending on aircap

Automatic spray valves



SCHÜTZE MINI-spray valve MMFS

pneumatically controlled roundspray valve. Designed for spraying signature- and marking-colours. Very fine and small sprayjet.

nozzle and needle: stainless steel

available nozzle dimensions:

0.3, 0.5, 0.8, 1.0, 1.2, 2.0 mm Ø

roundspray aircap

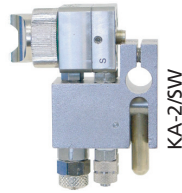

SCHÜTZE spray valve KA 2

pneumatically controlled spray valve in small design. Suitable for thin liquids as f.i. release agents and oils. Also available with quick release adapter (KA-2/SW).

nozzle and needle: stainless steel

available nozzle dimensions:

0.2, 0.3, 0.5, 0.8, 1.0, 1.2, 1.5 mm Ø

flatspray or roundspray pattern depending on aircap

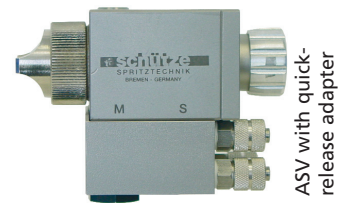
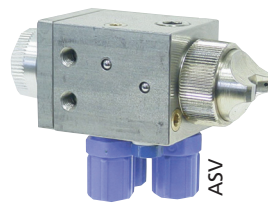

SCHÜTZE spray valve ASV

pneumatically controlled spray valve. Suitable for spraying release agents, oils, colours etc... Spray angle can be regulated individually from round- to flatspray without changing the aircap. Also available with quick release adapter.

nozzle and needle: stainless steel

available nozzle dimensions:

0.2, 0.3, 0.5, 0.8, 1.0, 1.2, 1.5, 2.0, 2.5 mm Ø



SCHÜTZE MINI-spray valve MSV and MVV

pneumatically controlled spray valve in miniature form. Suitable for thin liquids as f.i. release agents and oils.

measurements: 27x17.5x33mm, **weight:** only 60g

nozzle and needle: stainless steel

available nozzle dimensions:

0.2, 0.3, 0.5, 0.8, 1.0, 1.2, 1.5 mm Ø

flatspray or roundspray pattern depending on aircap

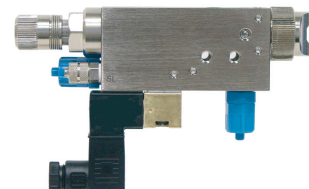

SCHÜTZE spray valve MKD-IS R/F

electro-pneumatically controlled spray valves. Suitable for thin liquids as f.i. release agents, oils and colours. With separate regulation of atomizing air for the middle and the horn air, integrated atomizing air valve.

nozzle and needle: stainless steel

available nozzle dimensions:

0.2, 0.3, 0.5, 0.8, 1.0, 1.2, 1.5, 2.0, 2.5 mm Ø

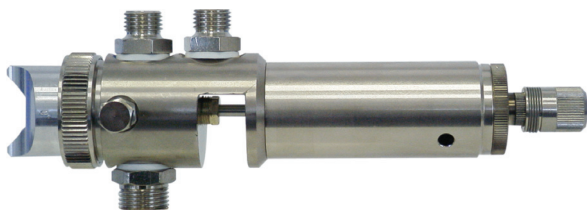

SCHÜTZE spray valve GF / 1 and GF / 2

These spray valves are robust apparatuses for application of colours, paints. Also suitable for spraying release agents and baking oils.

nozzle and needle: stainless steel

available nozzle dimensions:

0.5, 0.8, 1.0, 1.2, 1.5, 1.8, 2.0, 2.5, 3.0, 3.5 mm Ø

flatspray or roundspray pattern depending on aircap

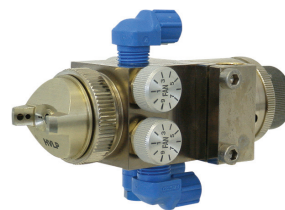

SCHÜTZE spray valve GF / 3

Designed for spraying colours, paints, etc. With integrated atomizing air valve for regulation of purging air. Spray angle can be regulated individually from round- to flatspray without changing the aircap.

nozzle and needle: stainless steel

available nozzle dimensions:

0.3, 0.5, 0.8, 1.0, 1.2, 1.5, 1.7, 2.0, 2.5, 3.0, 3.5 mm Ø

Automatic extrusion valves



SCHÜTZE spray valve GF / 4

Designed for spraying colours, paints, etc. Spray angle can be regulated individually by separate air connection from round- to flatspray without changing the aircap.

nozzle and needle: stainless steel

available nozzle dimensions:

0.3, 0.5, 0.8, 1.0, 1.2, 1.4, 1.5, 1.7, 2.0, 2.5, 3.0, 3.5 mm Ø

Also available in HVLP-technique

Automatic extrusion valves

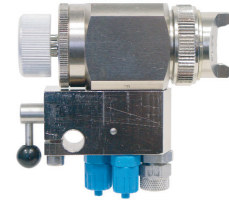

SCHÜTZE spray valve GF/5 with quick release adapter

The special of the series GF/5 is the possibility to change the spray valve within seconds without disconnecting or dismantling the hoses for air and fluid. Interruptions of work are reduced to a minimum.

nozzle and needle: stainless steel

available nozzle dimensions:

0.3, 0.5, 0.8, 1.0, 1.2, 1.4, 1.5, 1.7, 2.0, 2.5, 3.0, 3.5 mm Ø

Also available in HVLP-technique

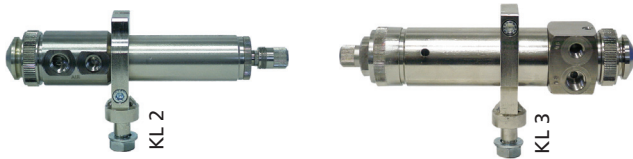

SCHÜTZE spray valve series KL

These spray valves are pneumatically controlled robust apparatuses for application of cold glues. Integrated atomizing air valve for regulation of purging air. Bellows diaphragm seal. Optional with clamp.

nozzle and needle: stainless steel

available nozzle dimensions:

0.8, 1.2, 2.0, 3.5 mm Ø

roundspray aircap

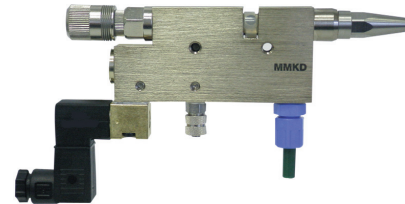

SCHÜTZE extrusion valve MMKD 30

Very fast and exact valve for continuous or intermittent application of oils and sealants. Available with long nozzle (LV) and short nozzle (KV). With solenoid valve.

nozzle: stainless steel, **needle:** tungsten carbide

available nozzle dimensions:

0.2, 0.3, 0.4, 0.5, 0.6, 0.7, 0.8, 1.0, 1.2, 1.5, 2.0, 2.5 mm Ø

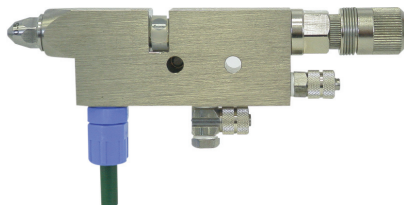

SCHÜTZE extrusion valve MMDV LV/KV

Small design. For continuous or intermittent application of oils and sealants. Available with long nozzle (LV) and short nozzle (KV).

nozzle: stainless steel, **needle:** tungsten carbide

available nozzle dimensions:

0.2, 0.3, 0.4, 0.5, 0.6, 0.7, 0.8, 1.0, 1.2, 1.5, 2.0, 2.5 mm Ø

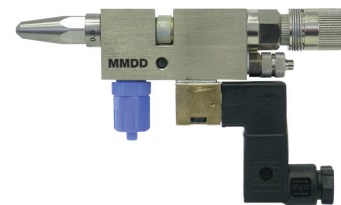

SCHÜTZE extrusion valve MMDD LV

Small design. For continuous or intermittent application of oils and sealants. Available with long nozzle (LV) and short nozzle (KV). With solenoid valve.

nozzle: stainless steel, **needle:** tungsten carbide

available nozzle dimensions:

0.2, 0.3, 0.4, 0.5, 0.6, 0.7, 0.8, 1.0, 1.2, 1.5, 2.0, 2.5 mm Ø

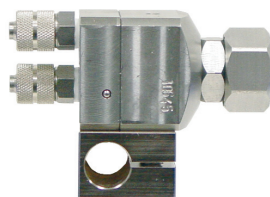

SCHÜTZE MINI airless spray valve KA-2/AIRLESS

The Mini airless spray valve KA-2/AIRLESS works without atomizing air.

measurements: 25 x 25 x approx. 60 mm, weight: only 140g

Max. material pressure: 150 bar (with two air connections)
120 bar (with one air connection)

All standard airless nozzles can be used.

needle seat: stainless steel, **needle:** tungsten carbide



SCHÜTZE airless spray valve S 830

Spray valve without atomizing air. Connections of valve on under-side. Control of S 830 via external pneumatic valves.

Max. material pressure: 250 bar:

All standard airless nozzles can be fitted to the S 830.

needle seat and needle:
tungsten carbide

Material pressure tanks



SCHÜTZE material pressure tanks of series Vol./..

for better handling of your spray intensions. Ideal for all spray jobs with a low material consumption, f.i. spraying release agents.

available volumes:

1, 2, 4, 6, 10, 20 and 40 ltr.

materials:

1-10 ltr = aluminium

20, 40 ltr. = stainless steel

options:

air motor stirrer, level reading device, connections for several sprayguns.

max. pressure: 2.5 bar

Accessories



SCHÜTZE material feeding device

for direct pumping of release agents, oils, colours and other liquids from 40 ltr. standard container.

complete with:

- double diaphragm pump Zip52,
- air motor stirrer,
- anti-pulsation tank,
- pressure regulators for air- and material-pressure.

max. pressure: 6 bar



SCHÜTZE material pressure tanks V2 / V5 / V10

are robust tanks made from stainless steel. All necessary fittings (f.i. two reducing valves, air stirrer motor) are installed on lid. With filler cap for easy re-filling.

available volumes:

2, 5 and 10 ltr.

options:

hand stirrer
level reading device
connections for several sprayguns

max. pressure: 6 bar



SCHÜTZE Zip52 double diaphragm pump

pump made from plastics, balls made from stainless steel.

incl. all necessary fittings as:

air pressure regulator for pump pressure,
air pressure regulator for atomizing air,
material pressure regulator,
anti-pulsation tank,
reflow faucet

max. pressure: 6 bar.



SCHÜTZE material pressure tanks V20 / V30 / V40

are robust tanks made from stainless steel. All necessary fittings (f.i. two reducing valves) are installed on lid. With filler cap for easy re-filling.

available volumes:

20, 30 and 45 ltr.

options:

air motor- or hand-stirrer, level reading device, connections for several sprayguns.

max. pressure:

V 20 and V 30 = 6 bar

V 40 = 4 bar



SCHÜTZE material pressure regulator

manual version

for regulating fluid pressures by hand.

Made from stainless steel.

Membrane made from Viton®/PTFE

pressure area: 0 - 7 bar

0 - 25 bar

0 - 50 bar

incoming pressure: max. 30 bar
max. 70 bar



SCHÜTZE material pressure tanks DG

low cost alternative. All necessary fittings (f.i. two reducing valves) are installed on top.

With handle and quick locking lid.

available volumes:

9 and 18 ltr.

The tanks of series DG are made from stainless steel.

max. pressure: 6 bar



SCHÜTZE filter

Inline-filter

for all hoses. For cleaning fluids or air. Filter housing made from stainless steel.

Available filter sizes:

50, 100 and 200 mesh.

SCHÜTZE high pressure filter
Designed for pressures up to 100 bar.

Made from stainless steel

Available filter sizes:

100, 150 and 200 mesh.

Accessories

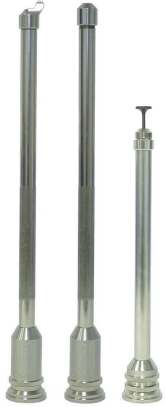

Extensions for sprayguns W1, W2, W7-N and spray valves GF1 and GF2
model V-A = spraying at an angle 90° or 45°
model V-G = spraying straight ahead
model V-R = spraying circular jet (360°)
standard lengths:
 200, 300, 400, 500, 600 mm
 Special versions on request.

Accessories

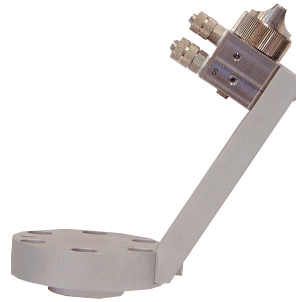

SCHÜTZE-special clamps for robot applications
 We design clamps for all valves as per your demands, f.i. for assembly on robots or other machines.



Extensions for spraygun W 3 FZ-Duo and spray valves MFS and KA 2
model V-A = spraying at an angle 90° or 45° or 90° twin head
model V-G = spraying straight ahead
model V-R = spraying circular jet (360°)
standard lengths:
 200, 300, 400, 500, 600 mm
 Special versions on request.

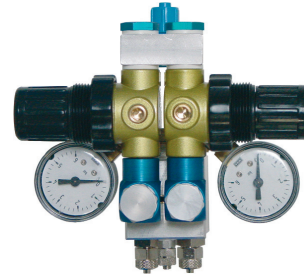

SCHÜTZE External control valve for pre- and purging air
 Suitable for all spray valves with separate connection for atomizing air and control air. For most applications a lower atomizing air pressure than control air pressure is needed. Besides this it is advantageous to have a temporal delay between atomizing air and control air.
Our external control valve combined all demands. In different versions available.



Extensions series D4 and D8
 special designed for small space demands.
for spray gun W 3 / FZ-Duo for spray valves MFS and KA 2
D4 = outer diameter 4 mm
D8 = outer diameter 8 mm
type D4: straight ahead or bended
D8 V-G = spraying straight ahead, roundspray
D8 V-R = spraying circular jet (360° hollow cone)
D8 V-45 = spraying at an angle 45°
D8 V-F = spraying straight ahead, flatspray.



SCHÜTZE special designed sprayheads
Development and production of:
 spray nozzles, extrusion nozzles, aircaps, complete sprayguns or spray valves with or without needle for individual application requirements.
materials:
 stainless steel, aluminium, brass, german silver, plastics...



SCHÜTZE Timer units

Pneumatically controlled timer units for SCHÜTZE spray valves.
Adjustment of: Material pressure, length of atomizing air, atomizing air pressure, length of purging air.
Length of atomizing air: 0,2 - 3 or 2 - 30 or 8 - 120 seconds

Development, production and assembly of other mechanical components or equipment, as f.i. special screws, distributors for air, distributors for fluids...

For the SCHÜTZE sprayguns and automatic spray valves also the appropriate hoses for air and fluid in different lengths and made from different materials available. Please contact us for further details.

Ability by experience

Spray technology to us means highest standards of precision and quality. Especially the tiny parts in a spray gun influence and settle the efficiency of an apparatus. The nozzle, needle and aircap design always receives our utmost attention.

To meet the actual and future demands that are put forward to us when designing modern spray techniques we always put the level of standard to be of very high order. Continuous investments in modern production methods guarantee optimum qualities of nozzles, needles, aircaps and the other components of SCHÜTZE-products.

Our engineering is well directed to the requirements of the application market. In co-operation with our customers the development of implements for application of various fluids is our job.

To achieve required droplet sizes our production and engineering have many opportunities to vary nozzles, needles and aircaps for individual application requirements.

Our customers gain by the long time experience and Know-How we have. Partnerships with customers and dealers at home and abroad guarantee the supply with SCHÜTZE-products and original spareparts worldwide. Today SCHÜTZE is known all over the world for precision and custom-made solutions in spray technology.

Already in year 1927 Mr. Alfred Schütze founded the company in Jena. Since 1959 principle place of business is Bremen. From the new start on in Bremen good connections abroad exists in many countries.

In first years after foundation Alfred Schütze produced mainly hand spray guns. Today the main production are automatic spray- and extrusion valves.

A lot of our products are individual solutions for special application requirements. For that reason it is not possible to show all our manufactured products in this product range.

Spraying or extruding release agents, oils, glues, adhesives, colours, paints, baking-fats..., in the SCHÜTZE-product range you can find the optimum solution.

Our slogan "from experts to experts" convinced many prospective customers of their good choice to work with SCHÜTZE. Contact us for your individual demands.

Precision is our program



PAKARTE



DISTRIBUTOR IN BALTICS:
PAKARTE LLC
Phone+372 5656 9482
pakarte@pakarte.com
www.pakarte.com

schütze

SPRITZTECHNIK

Hannoversche Str. 69-71, D-28309 Bremen
Postfach 44 86 48, D-28286 Bremen
Phone 00 49 (0)4 21 - 43 510-0
Fax 00 49 (0)4 21 - 43 510-43
www.schuetze-gmbh.de
info@schuetze-gmbh.de